

Configuration of WnjRPH

Release: V1.00 - 25/07/2018

<http://www.skynam.com>



Machine management

Configuration of WnjRPH

All the data and information to be found in these documents are subject to modifications without notice.

No part of the documents may be reproduced or transferred, whatever the reason or the means used, whether mechanical or electronic, without prior authorisation from Skynam.

Skynam's general sales conditions are fully applicable.

WINDOWS is a Microsoft Corporation registered trademark

The WINDOWS logo is a™ Microsoft Corporation trade mark.

Software licence

The Winjall software as well as its extensions are protected by copyright. When installing the software, you are accepting the licence registration conditions.

Licence registration

Skynam grants the buyer the sole, exclusive and non transferable licence right to use the software on one personal computer. Copying the software or any other form of reproduction whatsoever, either partly or totally, as well as mixing or linking it to other products, is forbidden. The buyer is entitled to make one single copy as a matter of safety precaution.

Skynam reserves the right to modify or improve the software without notice or to replace it by a new development. Skynam does not have to inform the buyer about modifications or improvements or to supply them. No legal obligation for quality has been given. Skynam cannot be liable for any damage due to improper use of the software, unless this particular damage is due to some deliberate action or negligence on Skynam's part or their employees'.

Skynam won't accept any responsibility about subsequent damage, whether direct or indirect or due to the use of the software.

IMPORTANT PRELIMINARY

This documentation has been specially updated for the WnjRPH versions distributed from July 25th 2018, notably WnjRPH V1.00

RPH RELAYS:

The family of RPH02,... performs Peak & Hold commands. They are used to control low-impedance devices, such as for example some solenoid valves whose impedance is less than 4 Ohms, that would not bear a simple On-Off command (also called saturated command) because the current command is too important and destroys these devices or the devices that control them (for example auxiliary outputs of an engine management ECU).

The number of commands tracks is shown in the number of the name of the relay:

- RPH02 has two command tracks
- ...

Each track of the Relay RPH can be configured differently from the other ones.

Your Relay RPH is provided with a standard tuning identical for all the tracks:

For the Peak:

- Type of control: Switching to the Hold as soon as the Peak current is reached
- Time of Peak: 5000 μ s (maximum time if the Peak current is not reached)
- Level of Peak 4 Amps

For the Hold:

- Level of Hold 1 Amp

For the relay configuration, Skynam has developed a user-friendly, performing software called WnjRPH.

With your PC, you'll need:

- A USB-FTDI interface provided by Skynam.
- WnjRPH software, properly installed on a PC (Microsoft Windows operating system, XP SP3, 7, 8, 10 or even more recent)

PRESENTATION OF RPH RELAY

I) GENERAL CHARACTERISTICS:

ELECTRICAL CHARACTERISTICS

After key power supply from 8 volts to 18 volts DC.

Consumption minimum while operating at 13 volts: 100 milliamperes,

Consumption on stop: 0 milliamperes,

Limit of maximal consumption: following the number of command tracks and of the current commands configuration.

TEMPERATURE CHARACTERISTICS

In operation, -40 ° to +65 °.

SEALING CHARACTERISTICS

Depends on the housing (contact us).

II) OPERATION CHARACTERISTICS:

INJECTORS COMMAND

2 command tracks

Trigger inputs commands by the ground, 1 KOhm pull-up resistor to +12V After Key integrated into the Relay.

Command covering of a channel on the other one allowed

Programmable Peak current from 1 to 16 Amperes

Programmable Hold current from 1 to 16 Amperes

Programmable Peak duration from 10 to 5000 microseconds

Two selectable Peak command types:

- the relay switches to the Hold as soon as the Peak current is reached. The Peak time is the maximum duration before the relay switches to Hold, in the case where the desired current is not reached.
- the relay controls the current during all the Peak time then switches to the Hold.

COMMUNICATIONS

A serial communication by USB-FTDI for the tuning of the commands control.

INSTALLATION OF RELAY RPH

These installation recommendations are simple but very important.

I) ELECTRICAL INSTALLATION :

When the engine is running, make sure that the relay is properly powered and that on-board tension (battery) at the input of the relay voltage is 13.7 volts.

The wiring of the grounds between the relay, the engine block and the battery must be impeccable, the resistance must be at most 0.1 Ohm taking account of the heel resistance of your multimeter (consult the installation instructions of the engine management ECU).

If the quality of the grounds is bad, the relay can be destroyed.

II) MECHANICAL INSTALLATION :

The relay must be installed in a vehicle area as cool and ventilated as possible, far from the exhaust heating.

Maximum ambient heat in the area in which the relay must be installed is 60 degrees.

Very often, in the series vehicles, the engine management electronic is installed behind a headlight, taking advantage of the circulation of fresh air, but protected from the weather.

In competition, it may be more difficult to protect the electronics from the weather if it is placed in a cool and well-ventilated area under the engine bonnet.

LOOM

RELAY RPH PEAK & HOLD

FUNCTION	CHARACTERISTICS	WIRE COLOR	WIRE DIAMETER
OUT	COMMAND OUTPUT A +	Positive Peak and Hold command	Grey
OUT	COMMAND OUTPUT A -	Negative Peak and Hold command	Grey
OUT	COMMAND OUTPUT B +	Positive Peak and Hold command	White
OUT	COMMAND OUTPUT B -	Negative Peak and Hold command	White
IN	TRIGGER INPUT COMMAND A	Command trigger -signal by the ground	Grey
IN	TRIGGER INPUT COMMAND B	Command trigger -signal by the ground	White
GROUND	POWER GROUND	Power ground input for the commands	Brown
SUPPLY	AK POWER SUPPLY	8-18 volts after key power supply	Red
GROUND	SERIAL COM GROUND	FTDI communication ground	Brown
IN	RX SERIAL COM	By FTDI communication	Blue
OUT	TX SERIAL COM	By FTDI communication	White

COMMANDS OUTPUTS

Each output command has two wires of the same color.

The coils of solenoid valves to be controlled have no polarity. The command + and command - can connect either one side or other of the device as long as you do not mix the colors (two gray together, two white together,...).

COMMANDS TRIGGER INPUTS

The wire color matches the color of the wires of the corresponding output.

Each command trigger input has a 1 KOhm pull-up resistor to 12 volt.

The device controlling the Relay (example engine management ECU) must provide an open-drain command:

- put this entry to the ground when it wants to control the track
- do nothing when it wants to stop the command track

PRINCIPLE OF INSTALLATION

Example for 2 solenoid valves

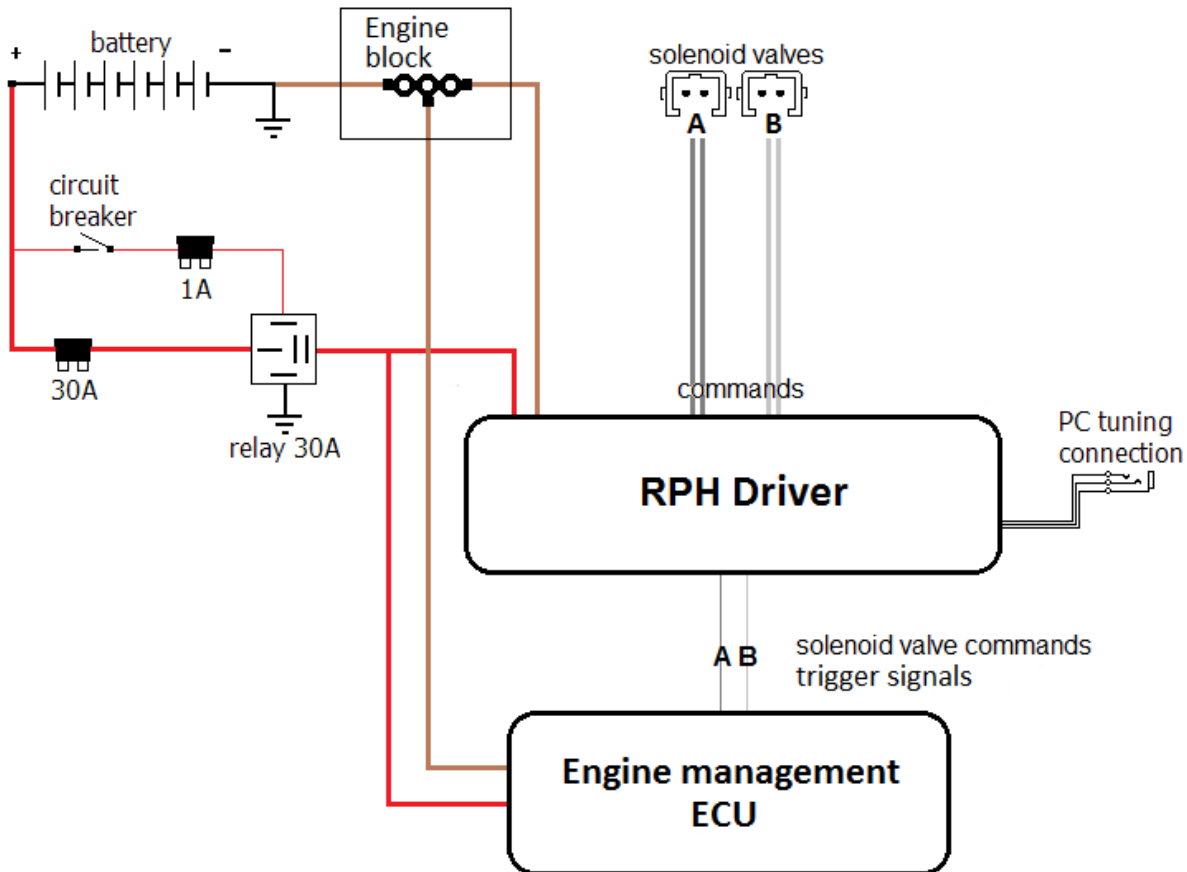

GROUNDS

The power ground of the relay RPH is wired at the same place than the engine management ECU one, on the engine block.

POWER SUPPLY

The After key power supply of the RPH relay is wired to the output of the relay which supplies the engine management ECU.

SOLENOID VALVE TRIGGER COMMANDS

These are the solenoid valve commands of the engine management ECU.

The RPH relay is interposed between these ECU commands and the solenoid valves.

POWER SUPPLY INSTALLATION WITH SYBELE ECU

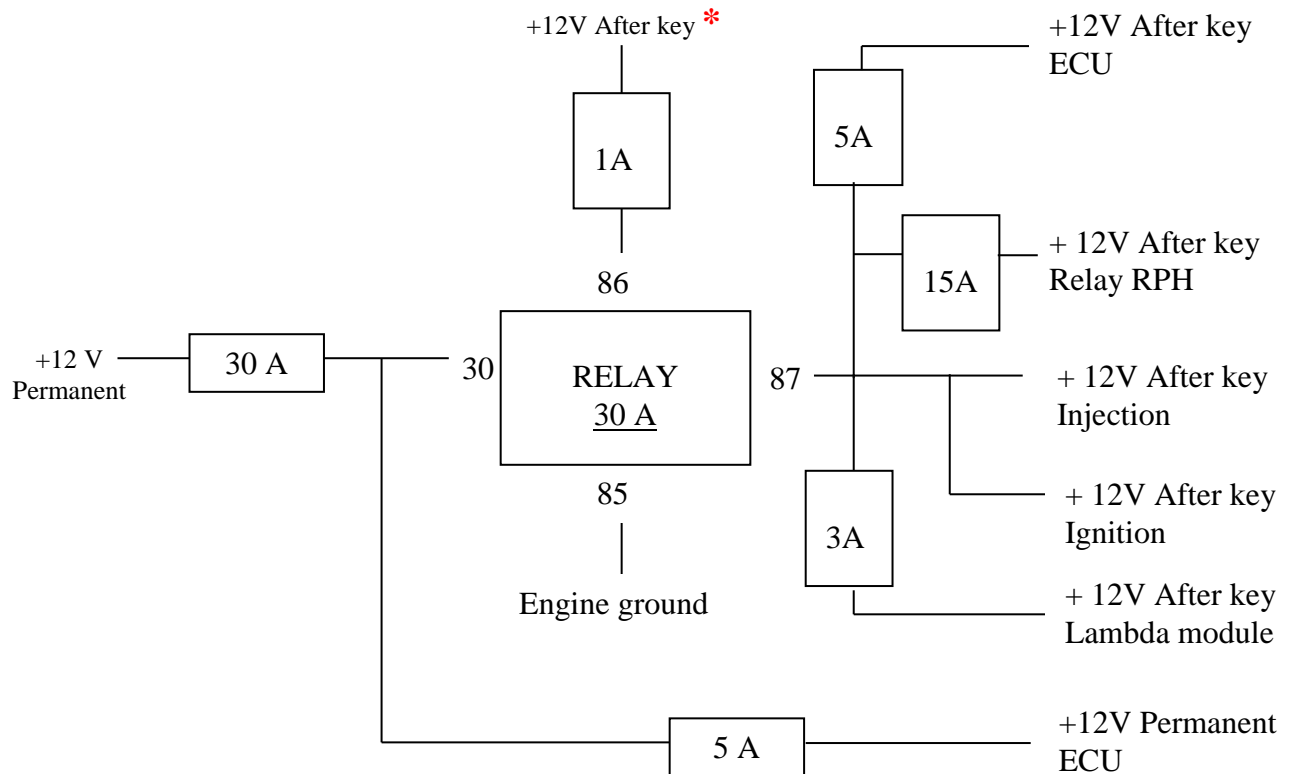

If not installed as described, we can't guarantee proper operation of the system.

*** The +12V after key has to be connected onto a switch for engine switching-off.**

When cutting off with the circuit-breaker, you would also switch off the alternator tension regulation, which may severely damage the ECU and the Relay: alternator tension not charged by the battery may jump over 30 volts.

RPH RELAYS CONFIGURATION

I) WNJRPH SOFTWARE LAUNCHING:

Before launching the WnjRPH software

USB-FTDI CONNECTION

Plug the USB-FTDI device into your PC and into the Relay female Jack.

SPECIAL RPH OPERATION FOR THE CONFIGURATION

During all the configuration, The RPH should not receive a command signal on its trigger inputs (the RPH trigger signal inputs must remain at rest) because it does not communicate while it is performing commands.

When the configuration will be completed, you can immediately make it work.

POWER THE RPH

Switch on ignition to start the RPH.

RUN THE WNJRPH SOFTWARE

Launch the software by double clicking on its icon on the computer desktop.



II) LANGUAGE SELECTION:

WnjRPH owns a main menu with a Preferences item.

Two languages can be dynamically selected by the 'Preferences' menu, English and French.



Note : two software packs are allowed, one French pack WnjRPH_FRA.1.0.0.0 and one English pack WnjRPH_ENU.1.0.0.0. These two packs do not concern the language used by WnjRPH but only the documentation language. So, whichever is the installed pack, you can select the operating language of the WnjRPH.

III) MAIN WINDOW OF WNJRPH :

The window in which runs WnjRPH only makes settings available when the program sees a RPH relay connected, that is, the RPH is properly connected to the PC, it is powered and it does not command its outputs.

Otherwise, a window requiring to connect the RPH appears.

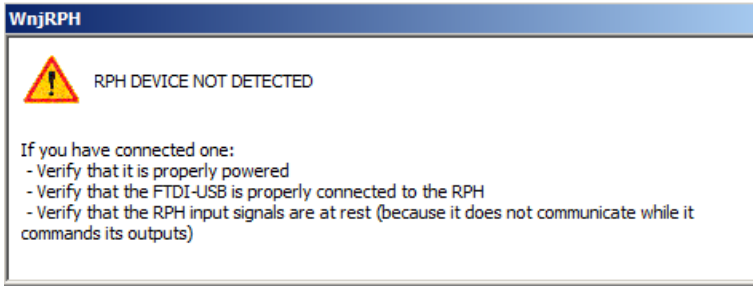

IV) CONTEXT HELP:

All the tunings owns a context help which remembers you what is the tuning used for and how you must use it.

To use the context help, click in the "?" in the upper left corner of the window. The mouse cursor becomes itself a "?".

Then click again on the tuning or the value or any part for which you need some help.

For example, if you require help on the type of Peak regulation:

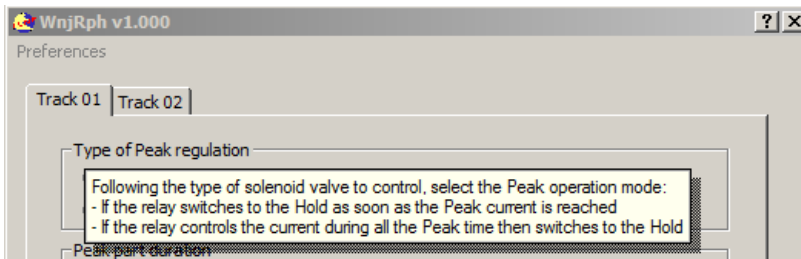

CURRENT COMMAND CONFIGURATION

Each of the two tracks of the relay owns its own tuning. The way to configure the two tracks is the same.

Click on the tab corresponding to the track that you want to look at and/or want to configure:

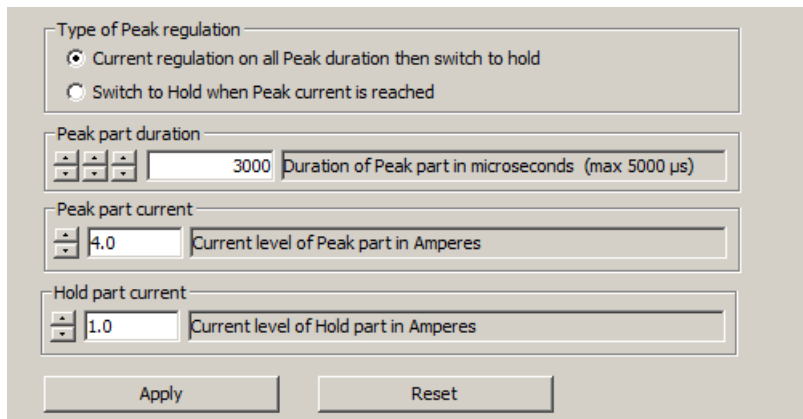
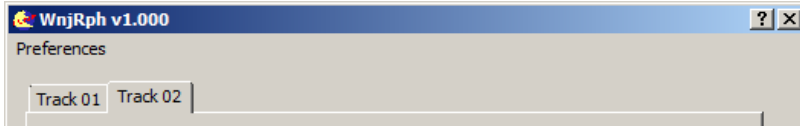

I) PEAK REGULATION:

TYPE OF REGULATION

Two types of Peak command are selectable:

- the relay switches to the Hold as soon as the Peak current is reached.
- the relay controls the current during all the Peak time then switches to the Hold.

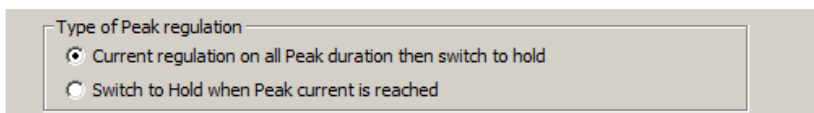

PEAK DURATION

Following the requested type of Peak, the relay uses the Peak time in two different ways:

- If the relay must switch to the Hold as soon as the Peak current is reached, the Peak time is the maximum duration before the relay switches to Hold, in the case where the Peak does not reach the desired current
- If the relay must control the current on all the Peak duration, it is the Peak control time before the diver switches to the Hold

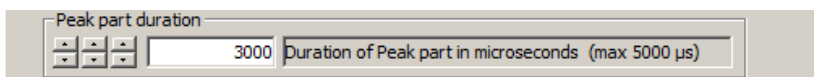

Use the left Spin to modify the time by 100 μ s, the center one to modify by 10 μ s and the right one to modify by 1 μ s

PEAK CURRENT

Can go from 1 to 16.0 Amperes by 1 Ampere steps

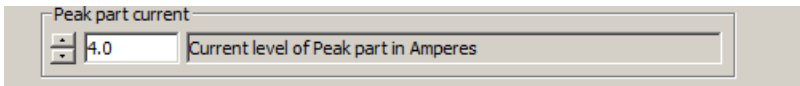

II) HOLD REGULATION:

HOLD CURRENT

Can go from 1 to 16.0 Amperes by 1 Ampere steps

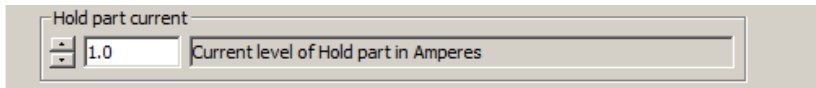

If you don't need to differentiate the peak and the hold current, you can tune them at the same level: the relay then acts as a simple hold current control.

III) VALIDATION OF THE CONFIGURATION :

When you have configured the command for the current track, to send this configuration to the RPH device, click on the [Apply] button.

To come back to the last applied configuration, click on the [Reset] button



To exit the WjnRPH software, click on [Completed] button:

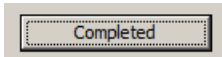

If you forget and try to exit without having applied, or reset, you will receive an error message:

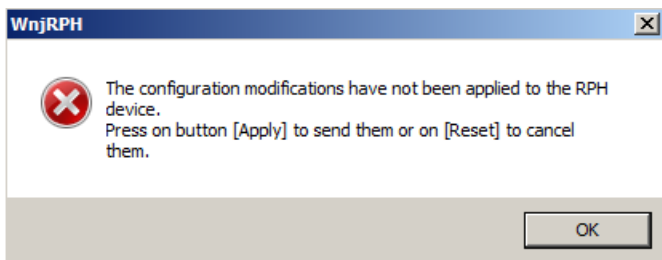

IV) EXAMPLES OF REGULATION:

PEAK SWITCHES TO HOLD AS SOON AS ITS CURRENT IS REACH

Example 1:

The current reaches the required level

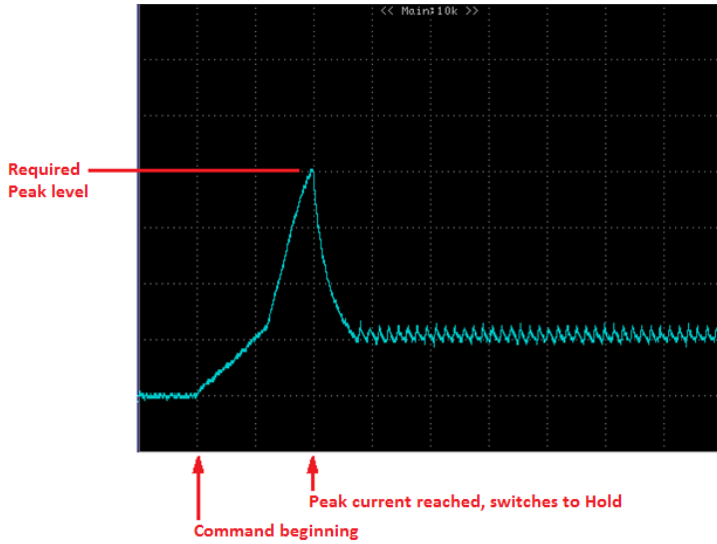

Example 2:

The current does not reach the required level, the Peak lasts the allowed maximum time

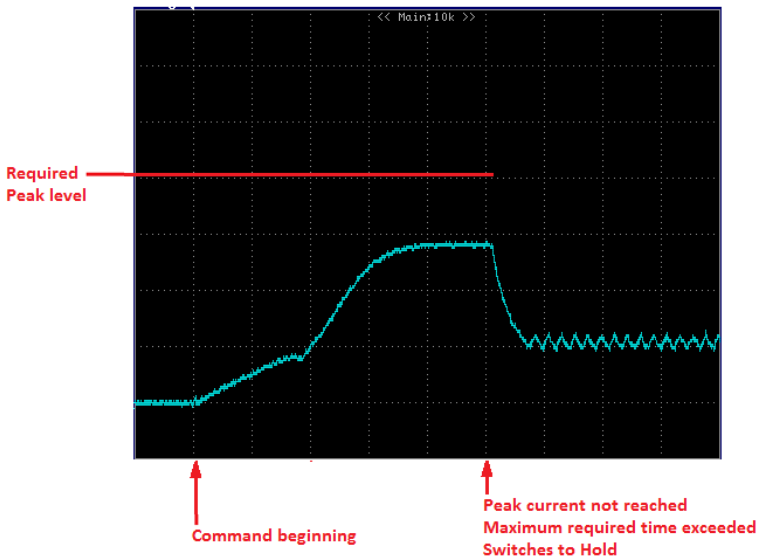

PEAK CONTROLS THE CURRENT DURING THE REQUIRED TIME THEN SWITCHED TO HOLD

