



MOD7CE™ (Marque déposée),  <http://www.mod7ce.fr/auto>
e-mail : mod7ce@gmail.com

Company 1 UNIQUE

bat.10, Parc club du Millénaire, 1025 Rue Henri Becquerel
F-34000 MONTPELLIER - France
RCS Montpellier n°540063997 - APE 7112B

INSTRUCTIONS MANUAL for Dashboard MOD7 G4-C

Thank you for purchasing this instrumentation MOD7CE® for your racing car.
We hope you will be pleased with it to advise us ...

About the story :

First there was the dashboard **MASTER7** (2008), then **MOD7-RR** (2011), then **EVO** (2015), and finally the ultimate version **MOD7 G4** which is the fourth generation with a new housing, a new electronic board and a new display screen for new functions
The dashboard **MOD7 G4-C** is working in **Canbus** with the ECU,
Please note that the **MOD7 G4-F** version is a wired version which cannot work in Canbus

Functions summary :

- Reading the informations from the programmable ECU by the CanH/CanL lines
- More than 15 integrated CAN protocols can be selected in the setting menu
- 1 digital input (Vehicle Speed) + 3 analog inputs available out of the Can network
- 2 data display pages
- 1 single push button to control the display screen and to program the dash
- 1 'over-display' screen to show the max recorded values when the engine stops
- 3 alert leds + 7 leds for full programmable shift light
- 1 home page with 'MOD7 RACING' logo
- 3 intensity levels to find a comfortable brightness of the display screen



Page 2



Page 1

Package contents for Dashboard MOD7 G4-C :

- 1 Dashboard MOD7 G4-C equipped with 4 anti-vibration pads fixing
- 2 Looms with 4 and 6 way connectors with 50cm wires
- 1 Push button to program and control the dashboard
- Option : 1 Speed sensor + 1 magnet
- 1 User manual

Technical specifications of the Dashboard MOD7 G4-C :

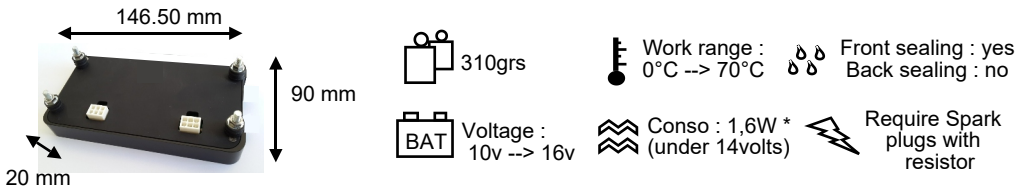

- **Maximum recorded values** : Engine speed, Throttle position, Vehicle speed, Water + Oil + Intake Temperatures et Oil + Fuel + Turbo Pressures
Display after engine turn off in an over-screen 'MAXI'.
- **Tachometer (CAN only)** up to 10600 rpm
Needle or Bargraph format up to 10600 rpm with programmable red zone for Bargraph
- **7 leds Shift Light** : 2 green working together, 3 orange and 2 red working together
Sequential turn on and then flashing when all are lighted
Each led can be programmed to turn on from 4000 to 10500 rpm with 100 rpm accuracy
- **Vehicle Speed (CAN or WIRE)** up to 250 km/h with 1 km/h accuracy.
When WIRE input : need a 'ils' sensor switched by a magnet (all supplied as an option)
Programmable wheel circumference from 140cm to 230cm
- **Engine Water Température (CAN only)**
Programmable alert (AL1 yellow led) from 80 to 120°C
- **Engine Oil Temperature (CAN or WIRE)**
When a WIRE input is selected : use a VDO 150°C sensor (*not supplied*)
Possible adjustment of the displayed value from -30°C to 0 and from 0 to +30°C
Programmable alert (AL2 yellow shared led) from 80 to 130°C
Orange warning symbol on the display screen
- **Engine OIL Pressure (CAN or WIRE)** from 0 to 9.0 bars (+/- 0,1 bar accuracy)
When a WIRE input is selected : use a 10 bars VDO sensor (not supplied)
Programmable alert (2 Blue leds) from 0.5 to 2.0 bars
- **Fuel Pressure (CAN only)** from 0 to 9.0 bars (+/- 0,1 bar accuracy)
Programmable alert (AL2 yellow shared led) from 2.5 to 4.5 bars
Orange warning symbol on the display screen
- **Turbo Pressure (CAN or WIRE)** from 0 to 2.5 bars (+/- 0,1 bar accuracy)
When WIRE input : use a 2 bars VDO sensor (not supplied)
When CAN input : displays the intake pressure
Programmable alert (AL2 yellow shared led) from 0.5 to 2.5 bars
Red warning symbol on the display screen
- **Fuel Gauge (WIRE only)** up to 60 liters
Uses the original sensor of the fuel tank. Programmable with steps of 10 liters
Orange warning symbol on the display screen when level reaches 10 liters
- **Gearbox Indicator (CAN only)**. Displays R, N, 1, 2, 3, 4, 5 et 6
- **Voltmeter, Throttle, Intake Pressure and Temperature (CAN only)**

Cautions and Safety precautions :

- This dashboard **MOD7 G4-C** is only reserved for use in racing cars.
It is not approved for a road use.
- A battery voltage above 16v might cause irreparable damages to the product.
- The **dashboard MOD7 G4-C** needs eventually some sensors witch are not supplied
At first, you can use the existing sensors of the car (oil temperature and pressure).
The displayed values may be incorrect or false but there is no risk to try them.



- Switch off the ignition and disconnect the ground terminal of the battery
- Keep the wiring harness far from hot spots of the engine (i.e. temperature)
- Install a fuse of 2 or 5A on the '+' power wire



- Use the mounting system supplied with the dashboard ('silentbloc' x4 parts)
- Make sure that the positive power supply will stay below 16 volts
- Do not pull on wires or harness and Do not spray the counter even at low pressure

CAN network adaptation :

The CAN network, consisting of the 2 lines CanH + CanL needs two 120ohms resistors
The ECU provides the first one. If you connect only the dashboard on the Can network, you don't have to do anything because the dashboard provides the 2nd resistor
On the other hand, if you have a other Can equipment on the Can network, you should disconnect its 120ohms resistor

Fixing the Dashboard MOD7 G4-C :

- **Choose** the best place for your **dashboard MOD7 G4-C** in order to see the full screen of the dashboard when you are in your driver seat :
The best place is at the location of the original instrument cluster
Replace them with a sheet of carbon or aluminium black painted.
An other good place is directly on the steering column, closer to you.
- **Drill** your support with 4 holes of 5mm diameter for the 4 silentblocs (see below)
- **Drill** your baseplate or support with 2 holes of 20mm diameter to pass the wires
- **Fix** the dashboard on your support using the 4 silentblocs.

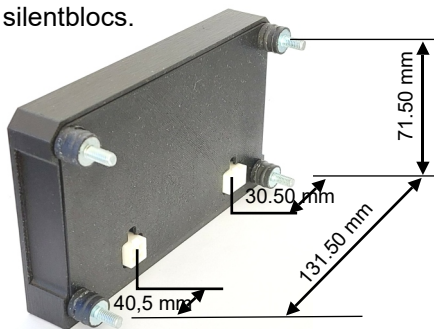

Wiring of the Dashboard MOD7 G4-C :

Precautions for supply connection :

- **Positive supply** : From the positive (+) battery plug, after the main switch, connect the ECU and the Dashboard 'in Y'.
- If you want to connect more equipments, connect them directly form the main switch
- **Negative supply (ground)** : From the negative (-) battery plug, connect with the same wire, the electronic ground of the ECU and the dashboard ground.
- if you need to connect more equipements, connect them directly from the battery plug
- **Negative ground power** : The engine block is tied to ground on the carbody
From this ground point, connect the ground power of the ECU

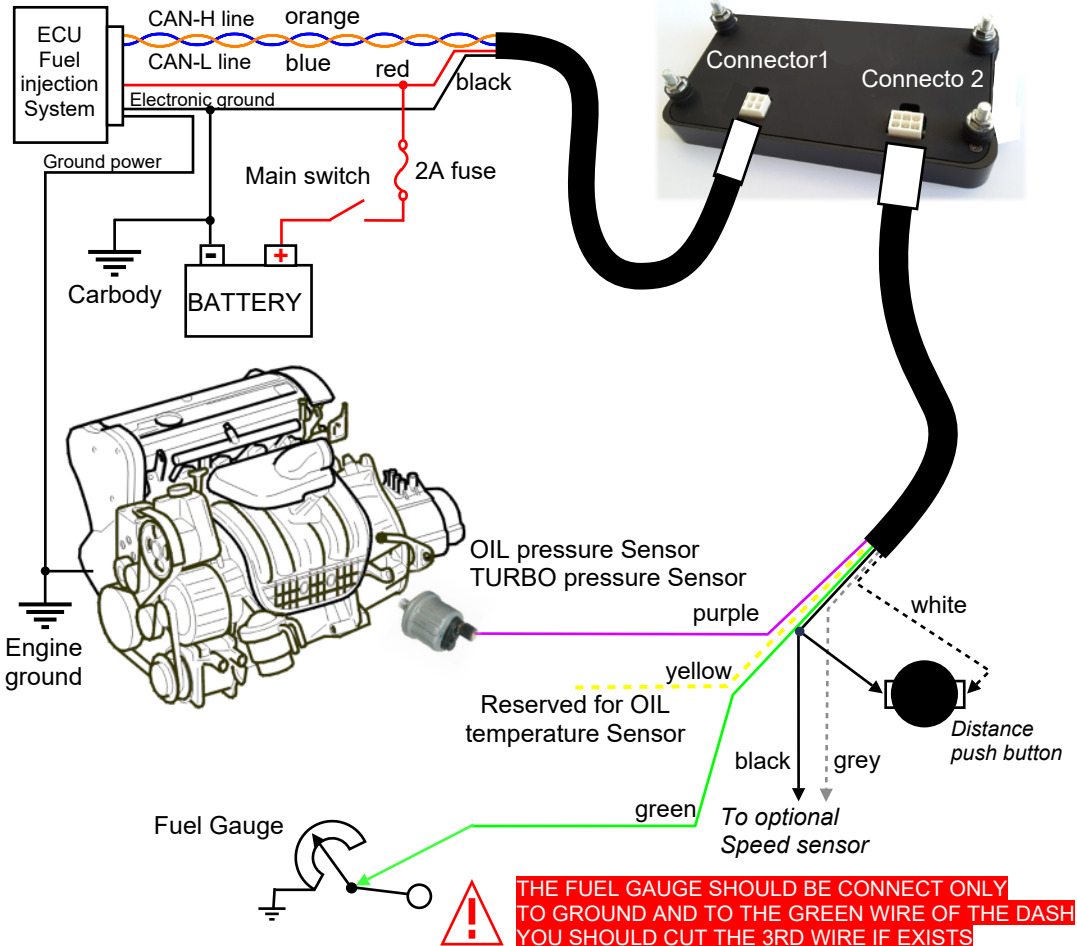

FUNCTIONS directly connected to the DASHBOARD :

- The Speedometer function exits on most of ECU Can protocols, but you can connect an 'ils' speed sensor directly to the dashboard connector 2 (See below)
- The fuel gauge function can be only read on the GREEN wire input of the Dashboard
- Only one pressure input is available on the dash which can be the Oil pressure or the Turbo pressure (Purple wire). The Fuel pressure function is always coming by CAN

ATTENTION : Each sensor you connect to the dash must be use only by dash !

Do not try to connect a sensor at the same time to the dash and to a meter or to the ECU, because it can destroy either the dashboard or the ECU input...

INSTALLATION of the SPEED SENSOR :

- **Paste** the cylindrical magnet on the half-transmission shaft near the gearbox output.
Use a good epoxy glue and even a non-metallic clamp.
- **Install** the 'PLA' speed sensor on an aluminium bracket (don't use steel) attached at one end to the engine block.
- **Connect** one of the sensor wires to the GRAY wire of dashboard **MOD7 G4-C**
- **Connect** the other wire to the BLACK ground wire of the dashboard (ground)

Speed sensor + Magnet :

Warning : *Sensor is fragile. Avoid hitting the sensor during installation*

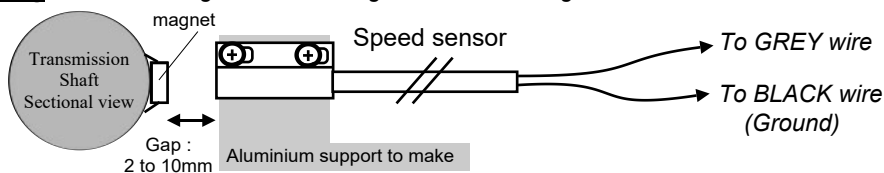

DISTANCE COMMAND PUSH BUTTON :

This dashboard **MOD7 G4-C** is supplied with a distance command wire (WHITE)
Connect this white wire to one termination of the push button.
Connect the other termination to ground (black wire)

Install the command button in order to use it when you are in your driver seat.
This button is used to control the brightness of the screen and to change the displayed page.

In case of problem with the CAN connection...

AT FIRST, VERIFY THAT THE CAN OUTPUT IS ENABLE IN THE ECU SOFTWARE !!!

Impedance adaptation on the CAN network :

- The CAN network needs two 120ohms resistors :

The ECU provides the first of these 2 resistors

The Dashboard **MOD7 G4-C** provides the second of the 2 resistors

If there is more than the dashboard and the ECU on the CAN network, you have to disconnect the other(s) 120ohms resistor(s) from the other equipment (Powerboard, ABS, Gearbox indicator, ...) more often in the equipment software or directly on the pcb board
If there is more the two 120ohms resistors on the CAN network the communication may no work !

Change the CAN speed :

- Most of the ECU works with a 1Mbps CAN speed and can communicates directly with the dash, as your dashboard **MOD7-G4** is programmed with this CAN speed as factory setting

If the communication doesn't work, you can change this CAN speed in the dashboard :

- Please read the information on page C2, at the paragraph 'CAN SPEED'
- After you change the CAN speed, you must save all the parameters, then cut off the power, then switch on the power to allow the dashboard to restart the communication with the new parameters.

Note : The CAN protocol type and speed are written at the top line of the display screen

Sometimes, if the communication between the ECU and the dashboard is not working, please try to power on the dashboard BEFORE powering on the ECU

OPERATING MODES :

A) Page changing (in normal mode, not configuration menu) :

HOME Page with the logo 'MOD7 RACING'

Page 1 : Tachometer with needle and several informations around

Page 2 : Bargraph tachometer and several informations below

NOTA : The first page to be displayed after the engine is running, or after you press the button is programmable in the configuration menu

- To exit the home page and access to the first choosen page, **briefly press** the button or start the engine
- To change page from 1 to 2 or from 2 to 1, **briefly press** the button
- To access to the configuration menu, when on the home page, **press and hold for 1 sec.** the button

When the engine is stopped, **press and hold for 1 second** the button to go back to the home page

Legend for continued arrow



A short press on the button =
Change page

Legend for discontinued arrow



A press and hold 1 second on
the button when the engine is
stopped = return to home page



HOME Page



Page 1



Page 2

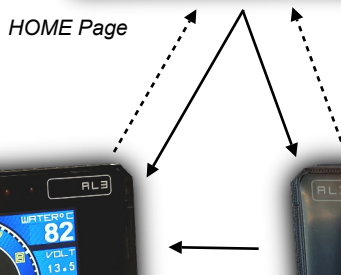

B) Configuration menu enter and exit :

The dashboard **MOD7 G4-C** doesn't need any connection to a PC or to a specific tool to be configurate. From the Home page, **press and hold 1 seconde** the button to access to the first level configuration menu

The different configuration menus and the complete explanations for the settings of the dashboard **MOD7 G4-C** are detailed in the CONFIGURATION section of this manual

All your parameters will be saved and the exit of the configuraton menu will take place when you leave the last line of the first level of the menu.

The display screen of the dashboard will be turned off, then turned on, as the same time, all the leds will turn on and off

C) Change the brightness of the screen :

To change the brighthness of the displat screen, when you are on page 1 or 2, while the engine is running :

- **Press and hold 1 seconde** the button to leave the Day mode (brightness is high) to Night mode (brightness is lower)
- **A second 'Press and hold 1 seconde'** action on the button changes the brightness from Night mode to an intermediate mode
- **A third 'Press and hold 1 seconde'** action on the button returns to the Day mode

D) Display of the MAXIMUM values :

When the engine is stopped, a overwindow is displayed on the selected page. As soon as you start again the engine, the normal mode appears again...

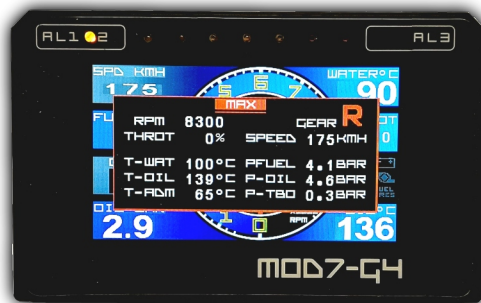

E) ALERTS leds and display :

- The Over-temperature Water alert uses its own alert : **the AL1 led**
- The Low pressure Oil alert uses its own alert : **the AL3 blue leds**
- The Turbo pressure, Fuel pressure, Low battery voltage, Low fuel level and Over-temperature oil alerts use a common alert : **the AL2 led**

So to determine which function(s) turn the led AL2 on, the dashboard **MOD7 G4-C** displays one or more pictograms on the screen